

Kessel / Chaudière / Caldaia / Ketel / Boiler

Optionen / Options / Opzioni / Opties / Options

**Gasrampe
Rampe gaz
Rampa gas** **Gasverdeelbuis
Gas train**

Einspeisung
Alimentation électrique
Allimentazione elettrica
Elektrische voeding
Power supply

F1
Sicherheitsbegrenzer
Th./pr. de sécurité
Termostato di sicurezza
Beveiliging thermostat
Safety limiter

S6
Begrenzer
Limiteur
Limitatore
Begrenzingsthermostaat
Limiter

H6
Störung
Panne
Inconveniente
Storing
Trouble

P4
Betriebsstundenzähler
Compteur horaire
Contaore
Urteller
Running hours meter

S7
2 Stufig oder PID
2 allures ou PID
2 stadi o PID
2 trap of PID
2 stages or PID

230 V~ 50Hz

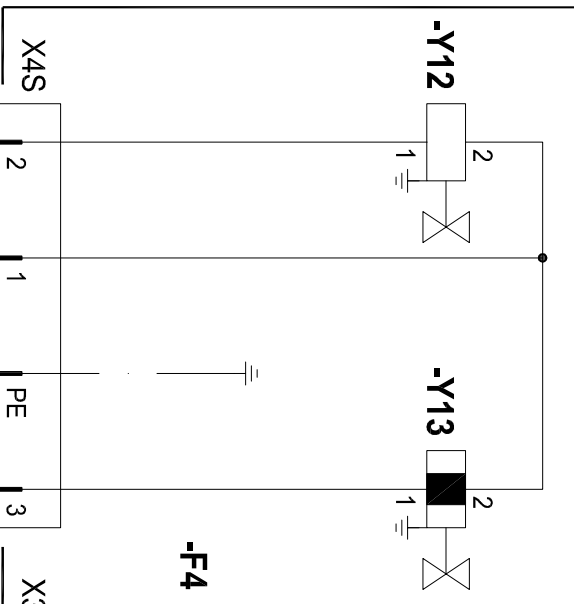
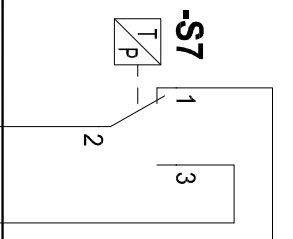
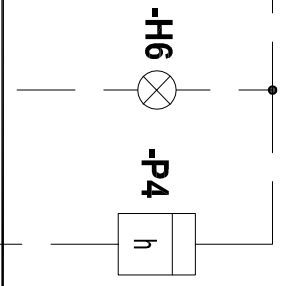
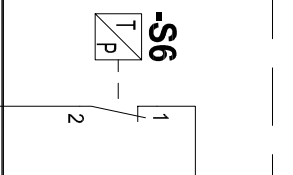
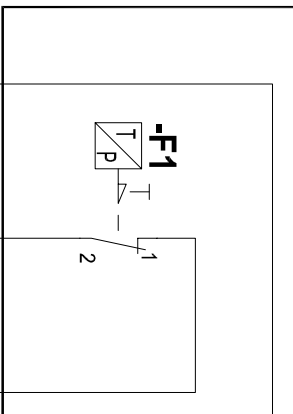
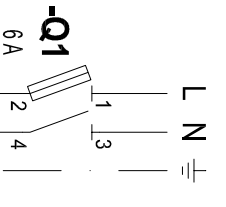

Brenner
Brûleur
Bruciatore

Brander
Burner
Bruciatore

X1S
X1B

A1
TCG 5XX

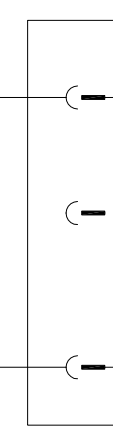
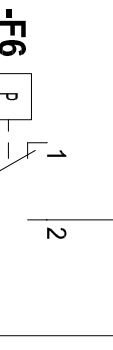
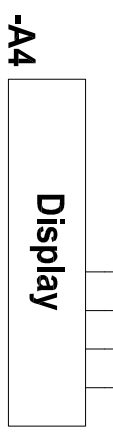
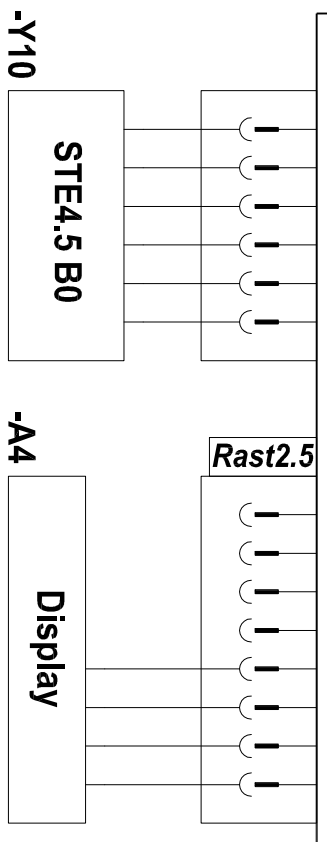

16/17
Anzeigevorrichtung oder Computer / Afficheur ou ordinateur /
Visualizzatore o computer / Utilizing of computer /
Display or computer

Der Schutz der Anlage muss den geltenden Normen entsprechen.
La protection de l'installation doit être conforme aux normes en vigueur.
La protezione dell'installazione deve essere in conformità alle norme in vigore.
Bescherming van de installatie moet in overeenstemming volgens de wettelijk geldende normen.
Protection of the installation must comply with the actual norms.

Erdung nach örtlichen Vorschriften / Mise à la terre conformément au réseau local /
Messa a terra in conformità alla rete locale / Aarding in overeenstemming met het plaatselijk net /
Earthing in accordance with local regulation

20
Reset / Déverrouillage / Sblocco /
Reset / Reset

21
Störung / Panne / Défaut / Inconveniente /
Storing / Trouble

